

Vapor Sensor

Installation Guide

Notice

Veeder-Root makes no warranty of any kind with regard to this publication, including, but not limited to, the implied warranties of merchantability and fitness for a particular purpose.

Veeder-Root shall not be liable for errors contained herein or for incidental or consequential damages in connection with the furnishing, performance, or use of this publication.

Veeder-Root reserves the right to change system options or features, or the information contained in this publication.

This publication contains proprietary information which is protected by copyright. All rights reserved. No part of this publication may be photocopied, reproduced, or translated to another language without the prior written consent of Veeder-Root.

Contact TLS Systems Technical Support for additional troubleshooting information at 800-323-1799.

DAMAGE CLAIMS / LOST EQUIPMENT

Thoroughly examine all components and units as soon as they are received. If any cartons are damaged or missing, write a complete and detailed description of the damage or shortage on the face of the freight bill. The carrier's agent must verify the inspection and sign the description. Refuse only the damaged product, not the entire shipment.

Veeder-Root must be notified of any damages and/or shortages within 30 days of receipt of the shipment, as stated in our Terms and Conditions.

VEEDER-ROOT'S PREFERRED CARRIER

1. Contact Veeder-Root Customer Service at 800-873-3313 with the specific part numbers and quantities that were missing or received damaged.
2. Fax signed Bill of Lading (BOL) to Veeder-Root Customer Service at 800-234-5350.
3. Veeder-Root will file the claim with the carrier and replace the damaged/missing product at no charge to the customer. Customer Service will work with production facility to have the replacement product shipped as soon as possible.

CUSTOMER'S PREFERRED CARRIER

1. It is the customer's responsibility to file a claim with their carrier.
2. Customer may submit a replacement purchase order. Customer is responsible for all charges and freight associated with replacement order. Customer Service will work with production facility to have the replacement product shipped as soon as possible.
3. If "lost" equipment is delivered at a later date and is not needed, Veeder-Root will allow a Return to Stock without a restocking fee.
4. Veeder-Root will NOT be responsible for any compensation when a customer chooses their own carrier.

RETURN SHIPPING

For the parts return procedure, please follow the appropriate instructions in the "General Returned Goods Policy" pages in the "Policies and Literature" section of the Veeder-Root **North American Environmental Products** price list. Veeder-Root will not accept any return product without a Return Goods Authorization (RGA) number clearly printed on the outside of the package.

Introduction

Contractor Certification Requirements 1
Product Marking Information 1
 Related Documents 1
Safety Warnings 3
Safety Symbols 3
Sensor Description 4
 Operating Capabilities 4
 Detection Capabilities 4
 Components 4

Sensor Installation 5

Figures

Figure 1. Check sensor openings for debris 5
Figure 2. Example Vapor Sensor Installation 6
Figure 3. Epoxy Sealing Field Wiring Connections 7

Introduction

This manual contains installation procedures for a Vapor Sensor.

This manual assumes the vapor monitoring well has been prepared with a removable cap to support the sensor and that field wiring has been run from the console to the well in which the sensor will be installed following instructions in the appropriate console's site prep manual.

Contractor Certification Requirements

Veeder-Root requires the following minimum training certifications for contractors who will install and setup the equipment discussed in this manual:

Installer (Level 1) Certification: Contractors holding valid Installer Certification are approved to perform wiring and conduit routing; equipment mounting; probe, sensor and carbon canister vapor polisher installation; wireless equipment installation; tank and line preparation; and line leak detector installation.

ATG Technician (Level 2/3 or 4) Certification: Contractors holding valid ATG Technician Certifications are approved to perform installation checkout, startup, programming and operations training, system tests, troubleshooting and servicing for all Veeder-Root Series Tank Monitoring Systems, including Line Leak Detection. In addition, Contractors with the following sub-certification designations are approved to perform installation checkout, startup, programming, system tests, troubleshooting, service techniques and operations training on the designated system.

- Wireless 2
- Tall Tank

Warranty Registrations may only be submitted by selected Distributors.

Product Marking Information

RELATED DOCUMENTS

Documents Required to Install Equipment

This intrinsically safe apparatus is only for use as part of a Veeder-Root Automatic Tank Gauging System (ATG Console with probes and sensors). To install intrinsically safe apparatus, use the specific control drawing that appears on the nameplate of the applicable associated apparatus (ATG Console):



Equipment	UL/cUL Control Drawing Document No.
Associated Apparatus	
TLS-450/8600	331940-008
TLS-350, TLS-350R	331940-011
TLS4/8601	331940-018

The control drawings contain information related to the correct installation of the overall intrinsically Safe System. This includes information such as maximum number of apparatus, specific apparatus allowed in the system, maximum cable lengths, references to codes, proper grounding and so on. Control drawings can be found on the

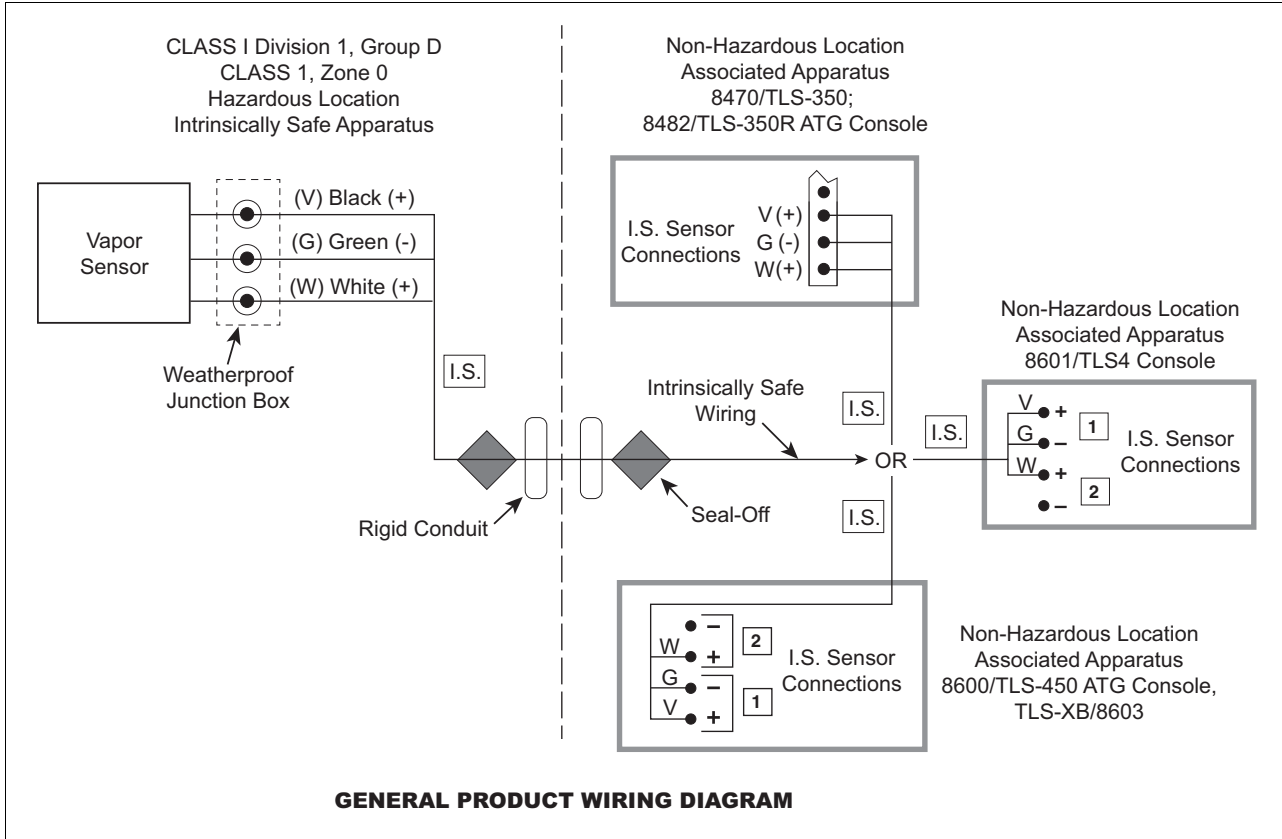
accompanying Compact Disk (TECH DOCS CD) or on the internet at veeder.com under SUPPORT; VR TECHNICAL DOCUMENTS; DRAWINGS.









Product Label Contents

 <p>CL I, DIV. 1, GP.D CL I, ZONE 0 AEx ia IIA Ex ia IIA TC=T4 SECURITE INTRINSEQUE</p>	<p>I.S. CIRCUIT FOR HAZLOC SENSOR</p> <p>-40°C ≤ Ta ≤ +60°C</p> <p>MANUAL NO. 576013-607</p>	<p>F/N 794390-XXX S/N XXXXXX</p> <p style="text-align: center;">2466 </p>
------------------------------------------------------------------------------------------------------------------------------------------------------------------------------------------------	----------------------------------------------------------------------------------------------	------------------------------------------------------------------------------------------------------------------------------------------------------------------------







Safety Warnings



To protect yourself and your equipment, observe the following warnings and important information:

 WARNING	
    	<p>This product is to be installed in systems operating near locations where highly combustible fuels or vapors may be present.</p> <p>FAILURE TO COMPLY WITH THE FOLLOWING WARNINGS AND SAFETY PRECAUTIONS COULD CAUSE DAMAGE TO PROPERTY, ENVIRONMENT, RESULTING IN SERIOUS INJURY OR DEATH.</p> <ol style="list-style-type: none"> 1. Read and follow all instructions in this manual, including all safety warnings to protect yourself and others from serious injury, explosion, or electrical shock. 2. Comply with all applicable codes including: the National Electrical Code; federal, state, and local codes; and other applicable safety codes. 3. To protect yourself and others from being struck by vehicles, block off your work area during installation or service. 4. Do not alter or modify any component or substitute components in this kit. 5. Warning! Substitution of components may impair intrinsic safety. 6. Field wiring to the Sensor must not share a conduit with any non-intrinsically safe device's wiring 7. Warning! To prevent ignition of flammable or combustible atmospheres, disconnect power before servicing. 8. Before installing or taking the unit into a hazardous area, earth the unit in a safe area to remove any static charge. Then immediately transport the unit to the installation site. Do not rub or clean the unit prior to installation. Cleaning is not required under normal service conditions. Do not rub or clean the unit after installation. If the unit is not fixed to a known earth point when installed, ensure that a separate earth connection is made to prevent the potential of a static discharge. When fitting or removing the unit, use of anti-static footwear or clothing is required. 9. Materials used in the construction of this device do not contain, by mass, more than 10% in total of aluminum, magnesium, zirconium and titanium or 7.5% in total of magnesium, titanium and zirconium.

Safety Symbols

The following safety symbols are used throughout this manual to alert you to important safety hazards and precautions.

 <p>EXPLOSIVE Fuels and their vapors are extremely explosive if ignited.</p>	 <p>FLAMMABLE Fuels and their vapors are extremely flammable.</p>
 <p>ELECTRICITY High voltage exists in, and is supplied to, the device. A potential shock hazard exists.</p>	 <p>TURN POWER OFF Live power to a device creates a potential shock hazard. Turn Off power to the device and associated accessories when servicing the unit.</p>
 <p>WARNING Heed the adjacent instructions to avoid equipment damage or personal injury.</p>	 <p>GLOVES Wear gloves to protect hands from irritation or injury..</p>

 <p>WEAR EYE PROTECTION Fuel spray from residual pressure in the lines can cause serious eye injuries. Always wear eye protection.</p>	 <p>INJURY Careless or improper handling of materials can result in bodily injury.</p>
 <p>NO VEHICLES Moving vehicles in the area during service can create a potential for personal injury to you or others. Sparks from starting vehicles can ignite fuels and their vapors</p>	 <p>USE SAFETY BARRICADES Unauthorized people or vehicles in the work area are dangerous. Always use safety cones or barricades, safety tape, and your vehicle to block the work area.</p>
 <p>NO POWER TOOLS Sparks from power tools (such as drills) can ignite fuels and their vapors.</p>	 <p>READ ALL RELATED MANUALS Knowledge of all related procedures before you begin work is important. Read and understand all manuals thoroughly. If you do not understand a procedure, ask someone who does.</p>

Sensor Description

The Veeder-Root Vapor Sensor detects the presence of hydrocarbon vapors in a dry monitoring well which could mean a dangerous leak. When vapors are detected that exceed a programmed threshold, the sensor sends a signal to the console. The monitor's visual and audible built-in indicators immediately tell you where the problem is, so you can quickly take action to prevent serious safety and environmental problems.

Operating Capabilities

- Operating temperature Range: -40°C to +60°C
- Storage Temperature Range: - 40° C to + 75° C.
- Dimensions: 4.88" long, 1.06" dia.
- Power Requirements: Intrinsically safe power supplied by the Veeder-Root console.
- Withstands removal and replacement from monitoring well without sensor damage.

Detection Capabilities

- Hydrocarbon vapor exceeding the programmed threshold triggers fuel alarm.
- Liquid present in the monitoring wells triggers a Water Alarm.

Components

Table 1. Standard Components

Qty.	Description
1	Vapor Sensor (Form No. 794390-700) and Cable
2	Watertight Cord Grips

⚠ CAUTION

A Veeder-Root Vapor Sensor should be installed only in wells where:

- Preliminary testing has determined that the soil is not contaminated beyond acceptable limits, or
- Where contaminated soil has been remediated and is now clean and present vapor levels are acceptable for its use.

A Vapor Sensor should not be installed in wells where preliminary testing indicates that the initial vapor sensor resistance exceeds 25K Ohms.

Sensor Installation



To prepare your equipment for sensor installation:

1. Turn OFF AC power to the console.
2. Remove the cap from the monitoring well.

WARNING



Do not perform drilling and tapping procedures in a hazardous area. Drilling and tapping can cause sparks and ignite fumes and liquids found in a Class I, Group D, Hazardous location. Failure to comply could result in death, serious personal injury, property loss and equipment damage.

3. Drill (0.703" dia.) and tap a 1/2-inch - 14 NPT pipe thread through the top of the cap.
4. Thread the furnished cord grip into the cap.
5. Determine the distance from the well cap down to a point that is 12 inches above the highest level to which the water table normally rises. If this level is not known, then take the measurement to a point 12 inches above the bottom of the monitoring well or 12 inches above any water in the well.
6. Pass the sensor cable through the cord grip from the inside of the cap until the bottom of the sensor is the distance from the cap equal to the measurement you made in step 6. Tighten the cord grip to secure the seal the cable entry into the cap.



Should the water table rise immersing the sensor and causing a water alarm, loosen the cord grip and reposition the sensor to hang (the higher of) 12 inches above the new water level or 12 inches above its previous position.

7. Before lowering the sensor body into the well, check the slots on each side of the sensor body and the hole in the bottom of the sensor body to ensure that no debris is clogging these openings.

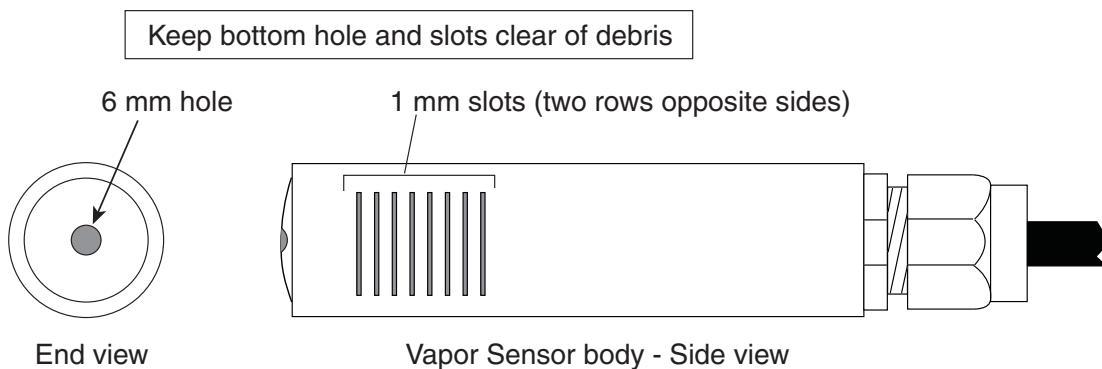

Figure 1. Check sensor openings for debris

8. Lower the sensor into the hole and replace the cap on the well (see Figure 2).
9. Measure the cable length required to reach to the sensor junction box and trim the cable accordingly.
10. Install the furnished junction box cord grip in one of the threaded junction box access holes.
11. Pass the sensor cable through the cord grip into the junction box. Tighten the cord grip to ensure a water-tight seal at the cable entry.
12. Using the wiring nuts, connect the wires from the sensor cable to the field wires from the console (see General Product Wiring Diagram on page 2). Observe polarity!
13. Seal wire nuts with epoxy sealant using one bag for two wire nut connections and another bag for the third wire nut connection. (See Figure 3).



NOTE: If more than two wire nut connections share an epoxy sealant bag, the connections will not be properly sealed. Improper sealing of these connections will result in inaccurate sensor readings and possibly false alarm conditions.

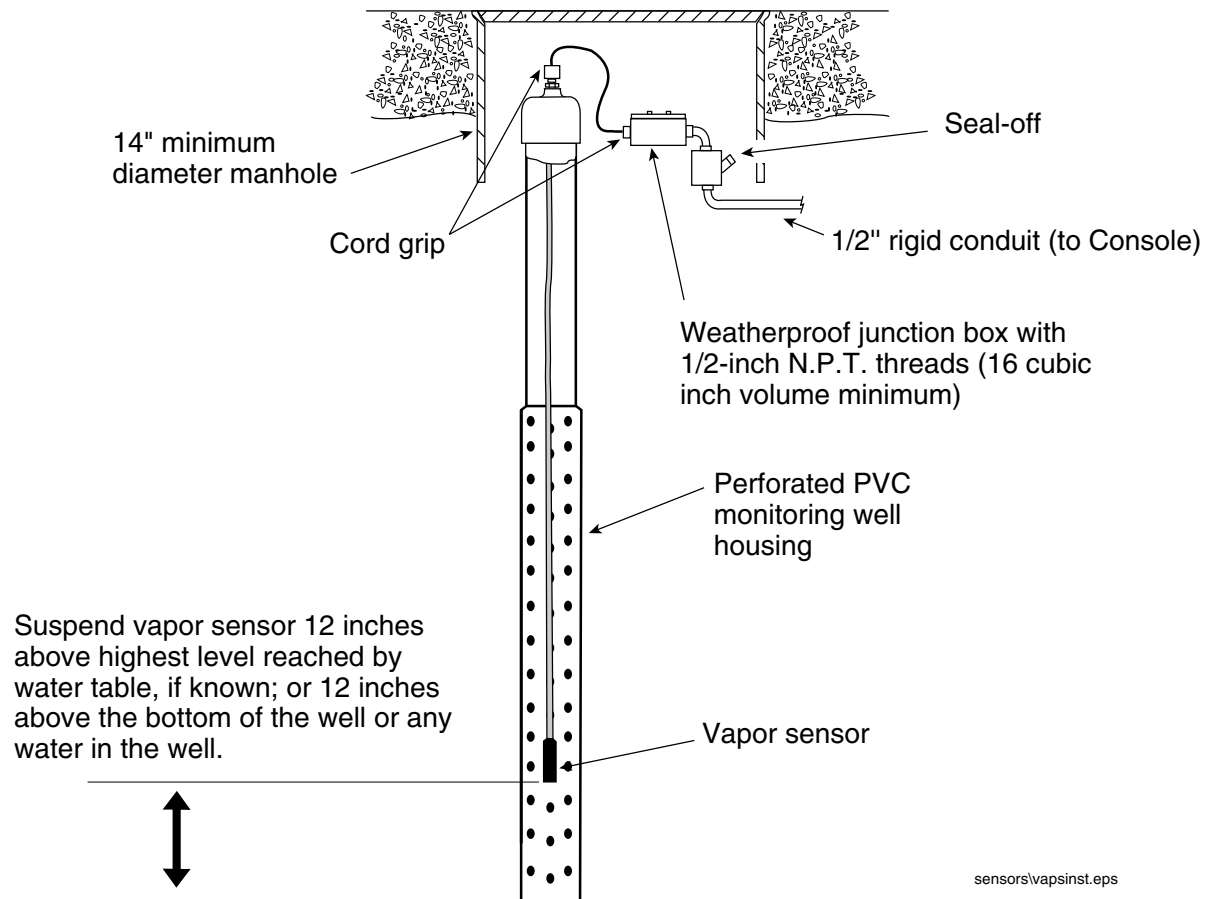
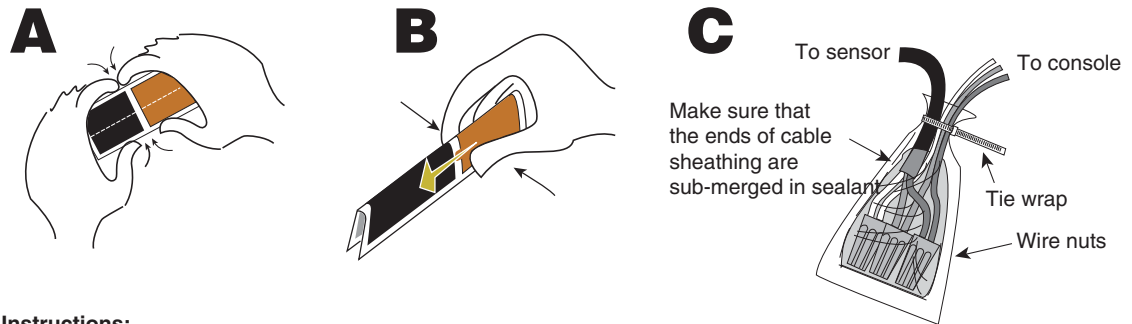

Figure 2. Example Vapor Sensor Installation





Instructions:

NOTE: When temperature is below 50°F (10°C), keep resin in a warm place prior to mixing (e.g., in an inside pocket next to body).

1. Open epoxy sealant package, and remove resin pak.
2. Holding resin pak as shown in A, bend pak along long length.
3. As shown in B, firmly squeeze the RED SIDE of the resin, forcing it through the center seal and into BLACK SIDE.

4. Mix thoroughly to a uniform color by squeezing contents back and forth 25-30 times.
5. Squeeze mixed, warm resin into one end of bag and cutoff other end.
6. Slowly insert wiring connections into sealing pack until they fit snugly against the opposite end as shown in C.
7. Twist open end of bag and use tie wrap to close it off and position the tie wrapped end up until the resin jells.

CAUTION: Epoxy sealant is irritating to eyes, respiratory system, and skin. Can cause allergic skin reaction. Contains: epoxy resin and Cycloaliphatic epoxy-carboxylate.

Precautions: Wear suitable protective clothing, gloves, eye, and face protection. Use only in well ventilated areas. Wash thoroughly before eating, drinking, or smoking.

consoles/epxy3w.eps

Figure 3. Epoxy Sealing Field Wiring Connections

